

# ケンタウルス

Centaur

作／図 宮島 登

Design & Diagrams By Noboru Miyajima

創作 1999年9月

作図 2007年4月

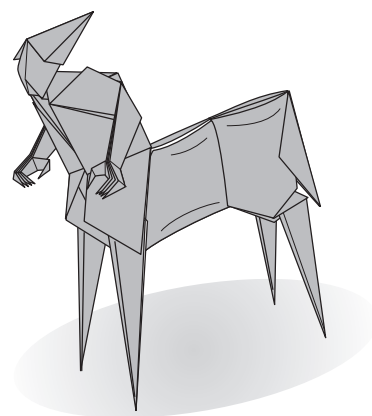

1

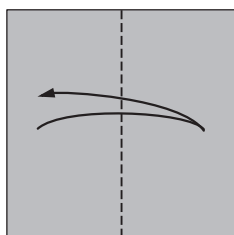

フチを合わせて折り筋をつける

2

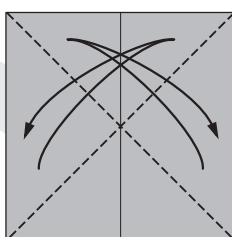

カドを合わせて折り筋をつける

3

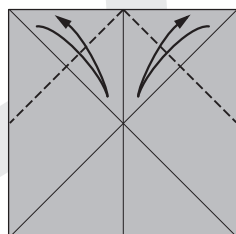

カドを中心に合わせて折り筋をつける (2箇所)

4

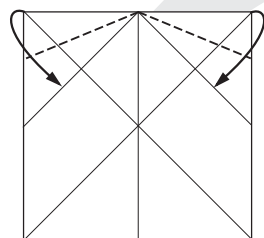

カドを折り筋に合わせて折る (2箇所)

5

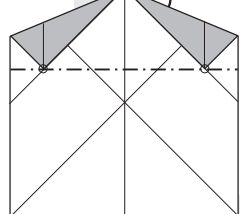

○を結ぶ線で後ろに折り返し折り筋をつける

6

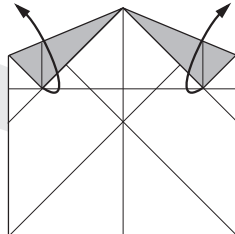

開く

7

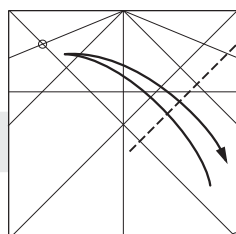

カドを○に合わせて折り筋をつける

9

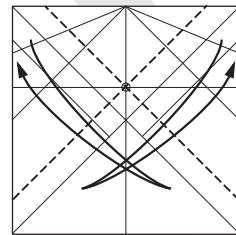

○を通る線で折り筋をつける (2箇所)

8

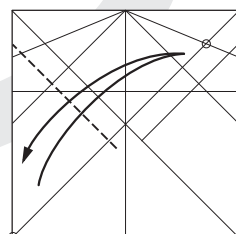

カドを○に合わせて折り筋をつける

11

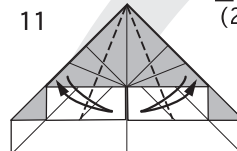

上の1枚だけ折り筋をつける (2箇所)

12



上の1枚だけ折り筋をつける (2箇所)

10

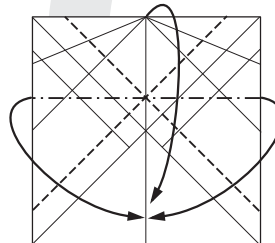

すでについている折り筋で風船の基本形の要領でまとめる

14

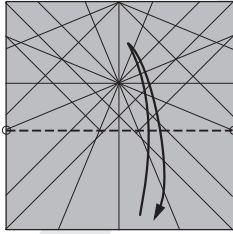

○を結ぶ線で折り筋をつける

15

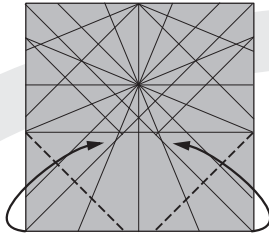

カドを折り筋に合わせて折る(2箇所)

16

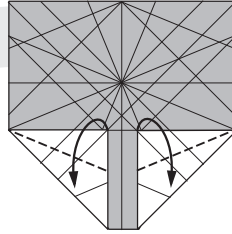

カドをフチに合わせて折る(2箇所)

17

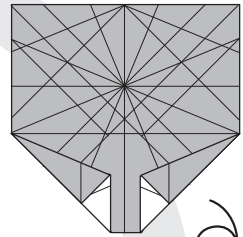

18

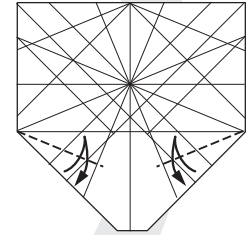

フチを折り筋に合わせて折り筋をつける(2箇所)

13

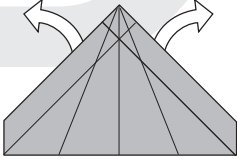

開く

19

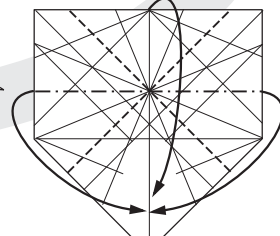

すでについている折り筋で風船の基本形の要領でまとめる

21

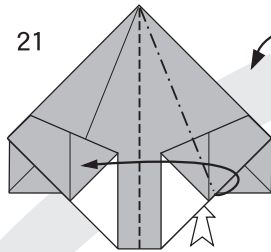

内側を開いてつぶすように折る

20

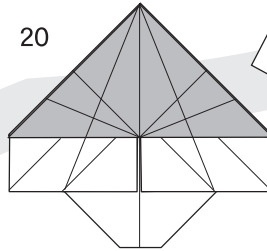

22

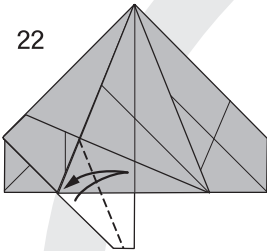

フチを合わせて折り筋をつける

23

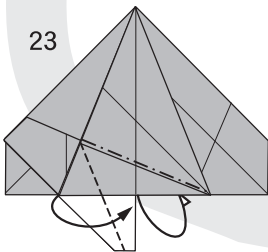

フチに沿って後ろに折り込む

24

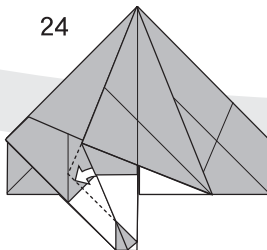

後ろに折り畳まれている紙を開く

25

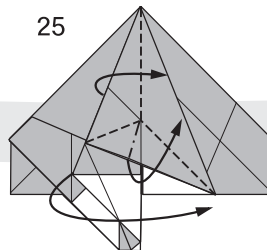

フチを合わせるように折り畳む

26

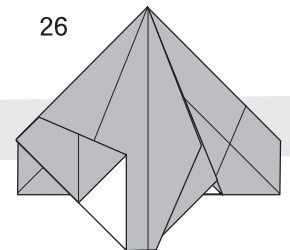

左側も同様に折る(21~25)

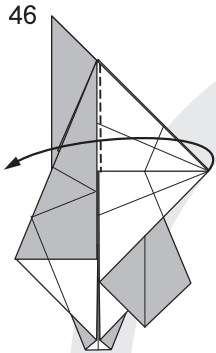

カドを左側へたおす

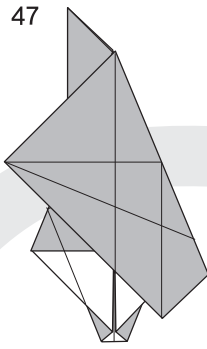

左側も同様に折る  
(42~45)

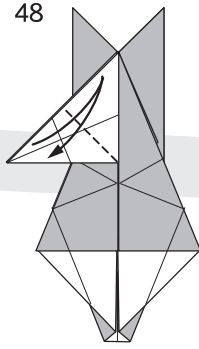

カドを合わせて  
折り筋をつける

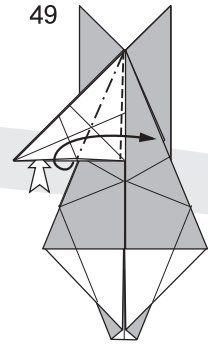

内側を開いてつぶす  
ように折る

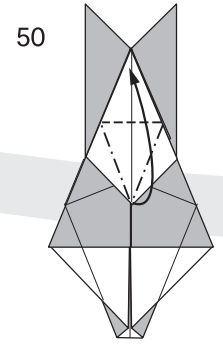

カドを合わせるように  
折り上げる

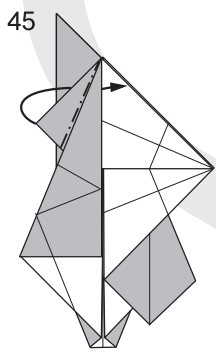

フチに沿って中わり折り

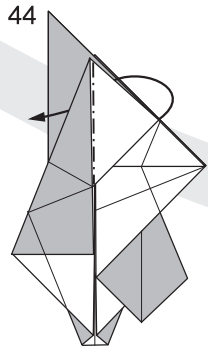

フチに沿って中わり折り

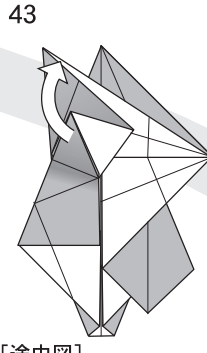

[途中図]  
下にあるカドも一緒に  
持ち上げる

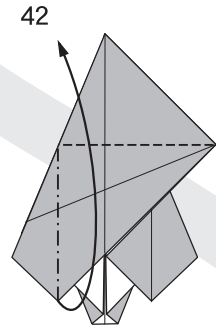

カドを半分に折りながら  
上に持ち上げる

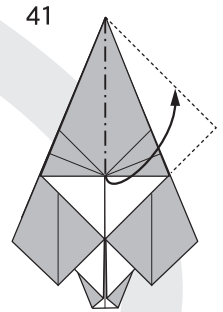

フチを持ち上げて畳む

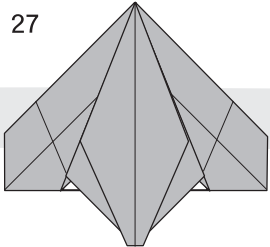

内側を開いてつぶすように折る

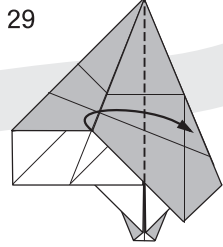

左側へ1枚たおす

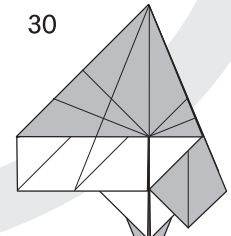

左側も同様に折る  
(28~29)

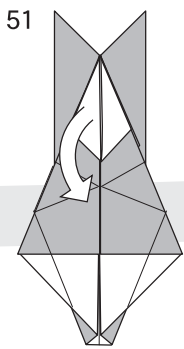

51

いったん開く

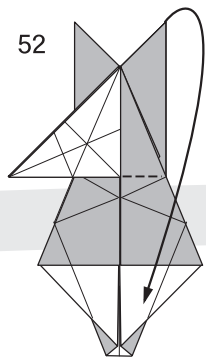

52

右側のカドを折り下げる

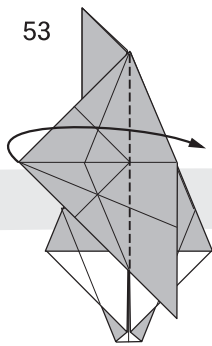

53

右側へたおす

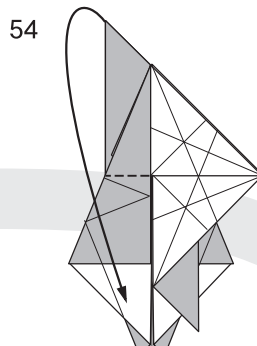

54

右側のカドを折り下げる

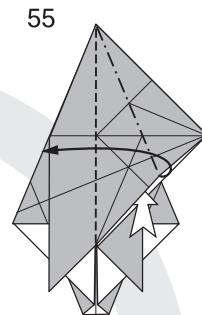

55

内側を開いてつぶすように折る

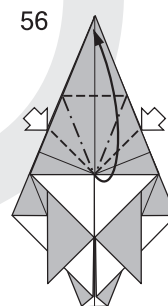

56

両側を押し込みながらフチをカドに合わせる

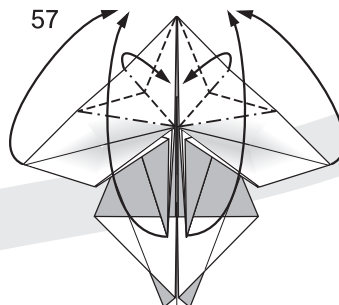

57

フチを中心に合わせながら計4つのカドを同時に持ち上げ、全体を平面に畳む

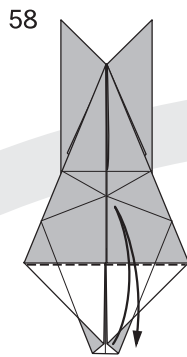

58

フチに沿っており筋をつける

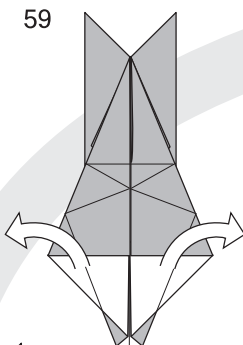

59

左右に広げる

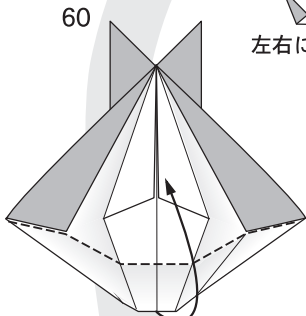

60

58 でつけて折り筋でフチを折り上げる

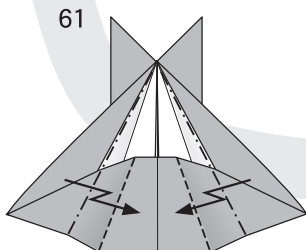

61

段折りして平面に畳む

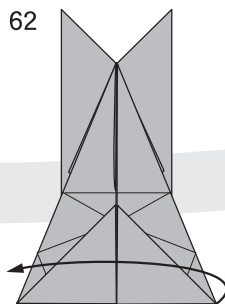

62

左側へ1枚たおす

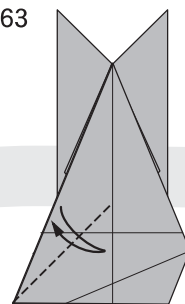

63

裏側のフチに沿って折り筋をつける

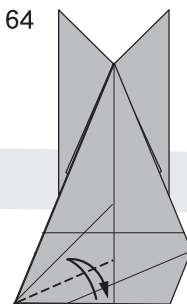

64

63の折り筋にフチを合わせて折り筋をつける

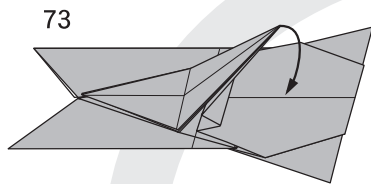

73

[途中図]

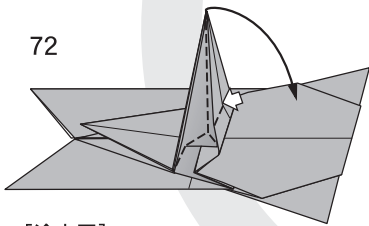

72

[途中図]  
白抜き矢印部分を押し込みながら  
カドをたおす

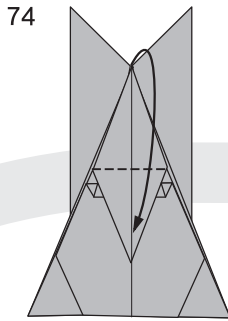

74

カドを折り下げる

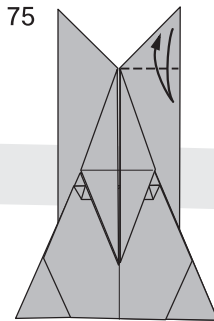

75

折り筋をつける

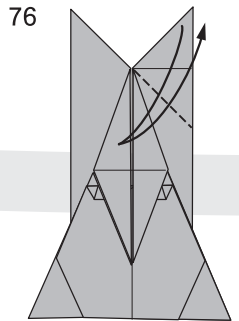

76

折り筋をつける

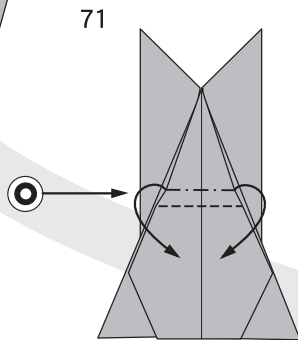

71

70の折り筋を山折りにつけかえ、  
手前の1枚だけを段折りして引き  
下げるように折る

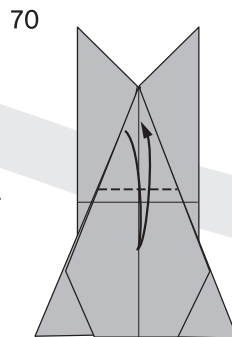

70

手前のカドだけ目一杯折り下げ  
折り筋をつける

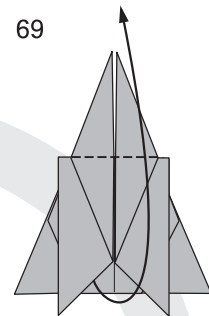

69

戻す

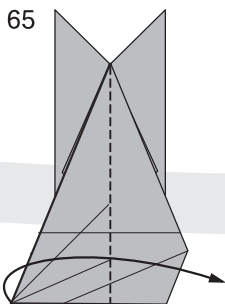

65

63の折り筋にフチを合わせて  
折り筋をつける

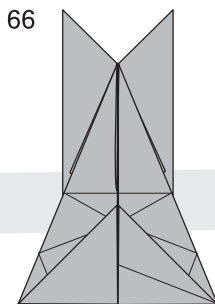

66

左側も同様に折る  
(62~65)

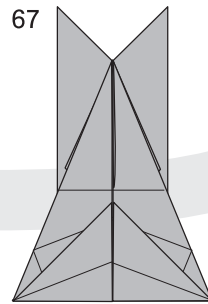

67

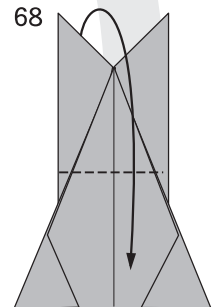

68

2つのカドを目一杯  
折り下げる

77

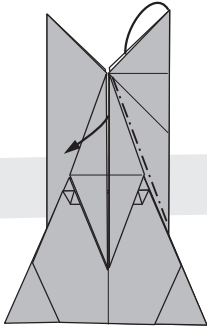

フチに沿って中わり折り

78

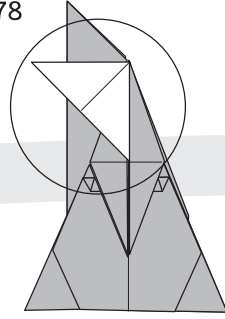

79

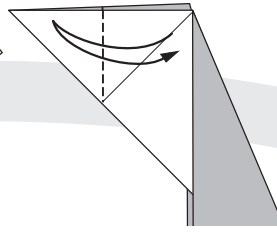

カドを合わせて  
折り筋をつける

80

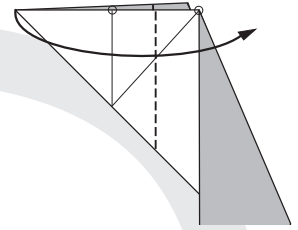

○を合わせて折る

81

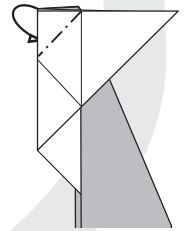

カドを後ろへ折り返す

82

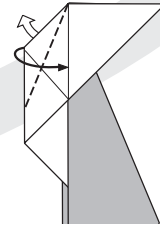

フチを合わせて折る  
(裏のカドは折らずに  
表に返す)

83

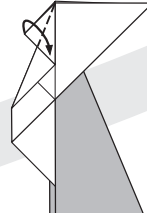

フチを合わせて折る

84

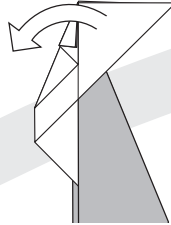

いったん戻す

85

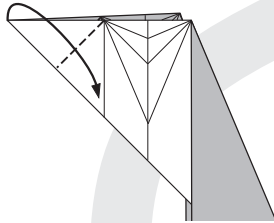

フチを合わせて折る

86

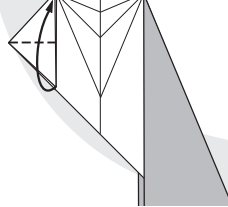

カドを合わせて折る

87

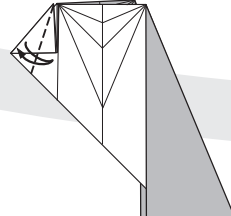

フチを合わせて  
折り筋をつける

88

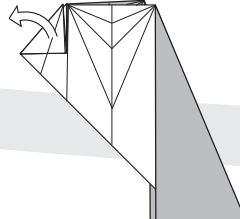

いったん戻す

89

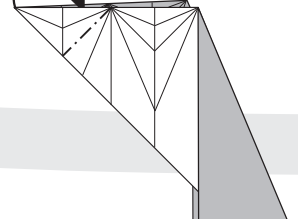

カドを内側へ折り込む

99

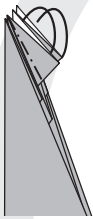

指部完成

100



指部完成

101

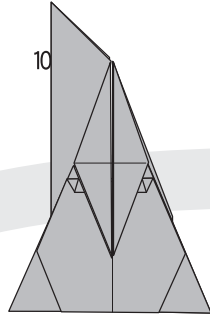

左側も同様に折る  
(75~99)

102

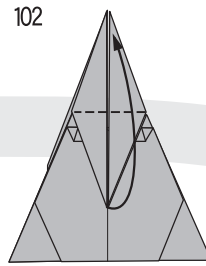

カドを折り上げる

103

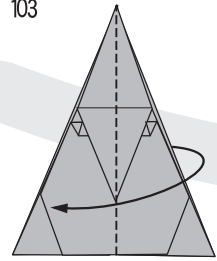

半分にたたむ



フチに沿って中わり折り  
(2箇所)

98

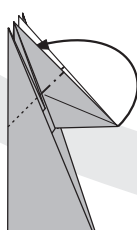

カドとカドを合わせる  
ようにして中わり折り

97

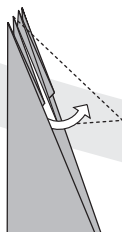

折り畳まれているカドを  
引き出す

96



まん中のカドをフチに  
沿って中わり折り

95

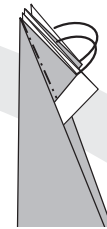

フチに沿って中わり折り  
(2箇所)

94

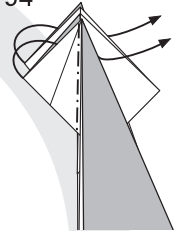

フチに沿って中わり折り  
(2箇所)

90

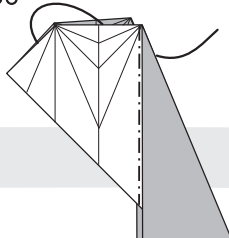

フチに沿って全体を  
中わり折り

91

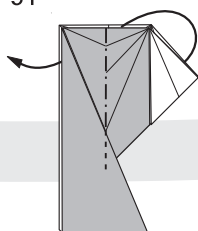

図のを折り筋で中わり折り

92

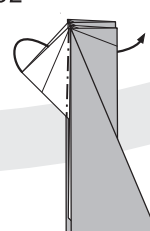

まん中のカドをフチに沿って  
中わり折り

93

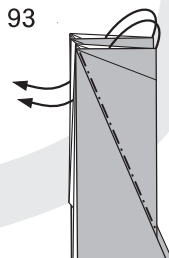

フチに沿って中わり折り  
(2箇所)

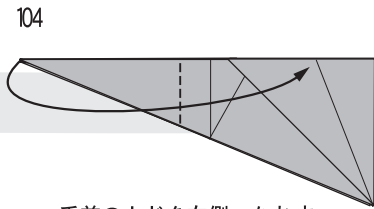

104  
手前のカドを右側へたおす  
(反対側も同じ)

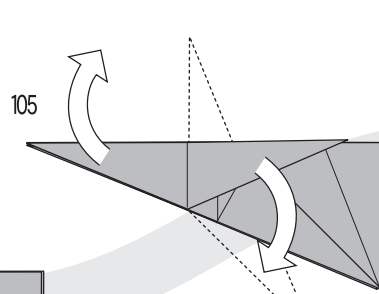

105  
カドを引っ張って、回転  
させるようにして、カド  
が垂直になるまでずらす

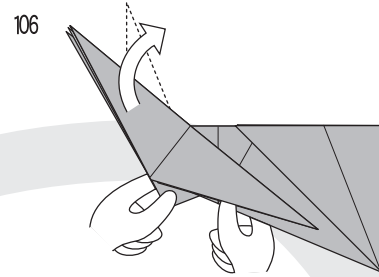

106  
[途中図]  
図のように内側に隠れている小さい  
カドを持つとずらしやすい。

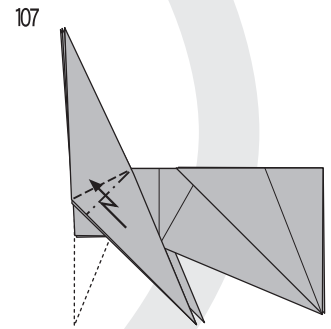

107  
段折りして、ずらすように折る  
(垂直になる)  
※以下、原則的に反対側も同様に  
折ること

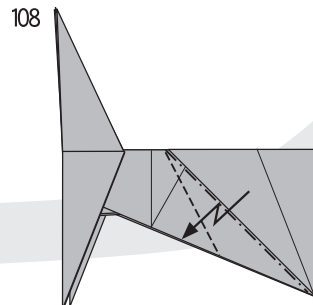
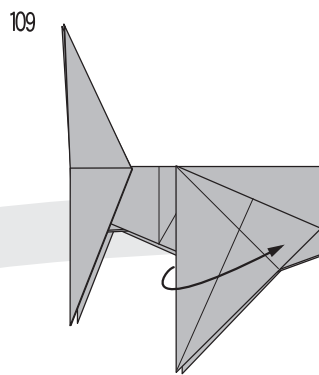
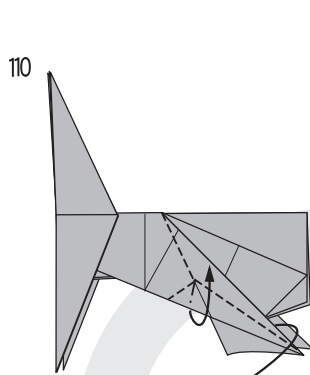

108  
段折りして、ずらすように折る

軽く開く

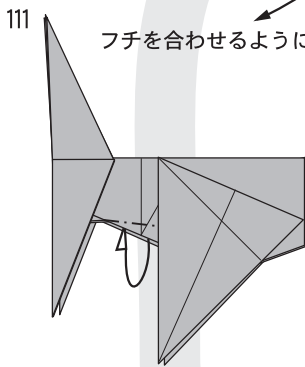

110  
フチを合わせるように折り畳む

フチを内側に折り込む

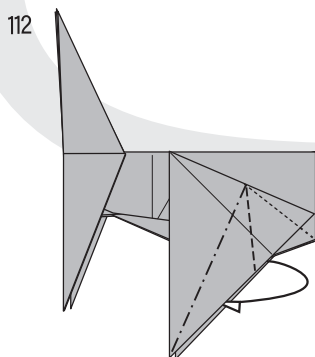

111  
ついている折り筋で後ろへ折り込む

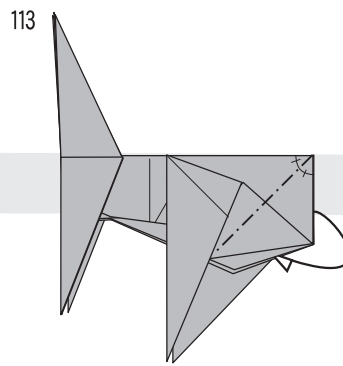

112  
半分の角度で内側へ折り込む

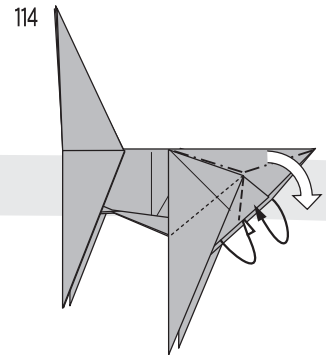

113  
フチを内側へ折り込みながら、  
カドをつまむようにして折り下げる

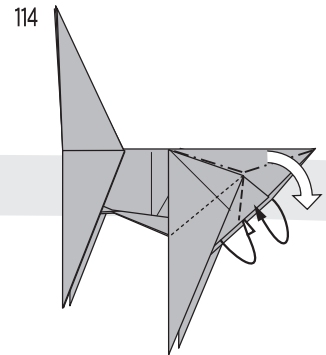



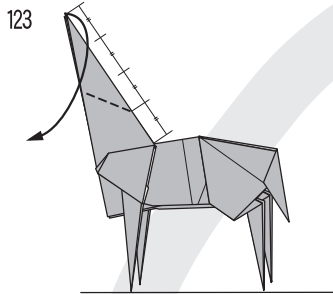

図の基準で手間のカドを折り返す

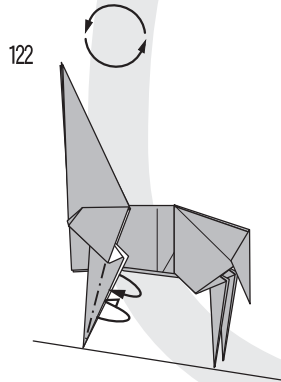

フチを内側へ折り込む  
※この段階では前足は後ろ足より短くてよい

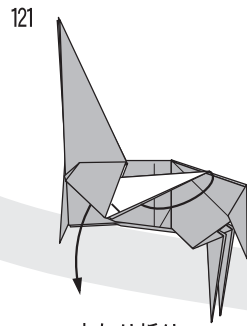

中わり折り

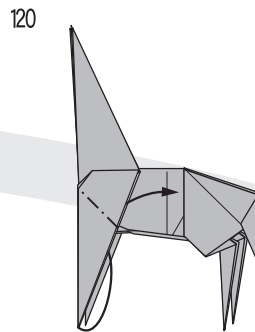

上から1枚めのところで中わり折り

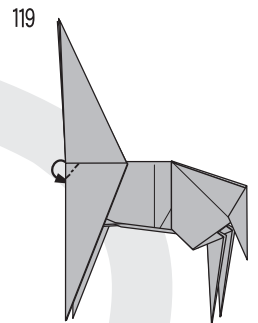

小さいカドを後ろへ折り込む

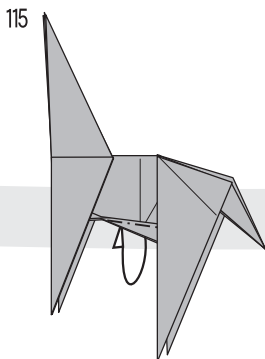

フチを内側に折り込む

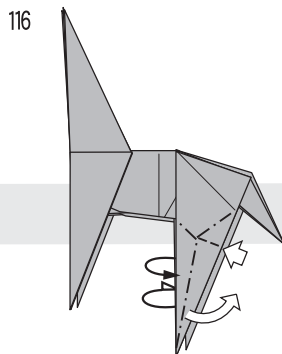

白矢印部分を押し込み、フチを内側へ折り込みながら、カドをつまむようにして折り上げる

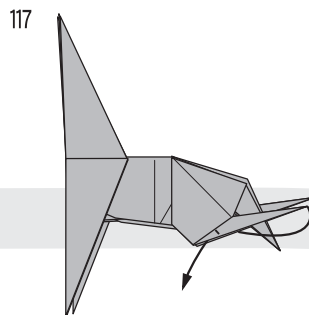

中わり折り

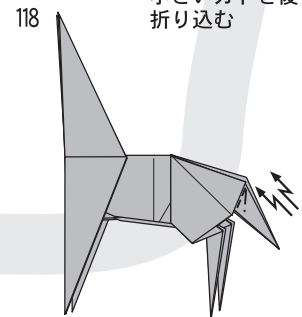

外側へななめに段折り

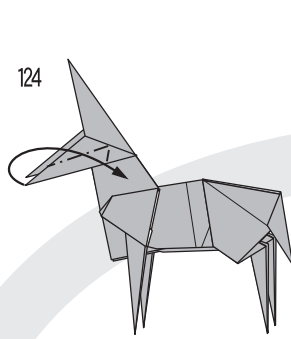

図のようにつまみ折り

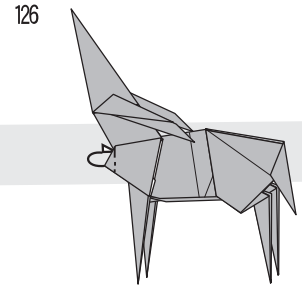
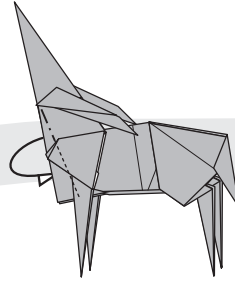

127

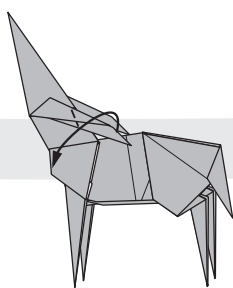

カドを折り返す

128

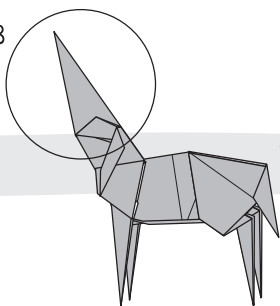

129

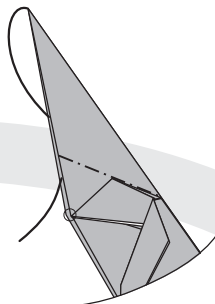

○に合わせて中わり折り

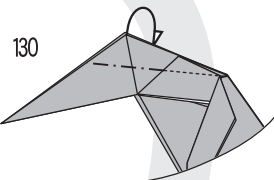

フチを内側に折り込む

131

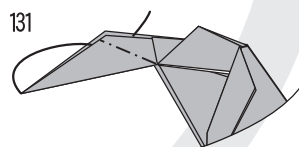

フチを内側に折り込む

132

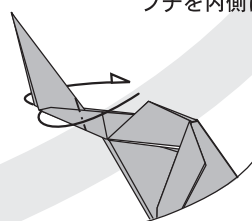

かぶせ折り

133

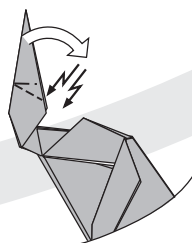

外側へななめに段折り

134

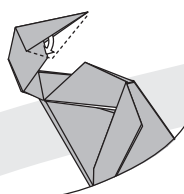

内側の紙を引き出す

135

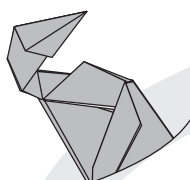

頭部完成

136

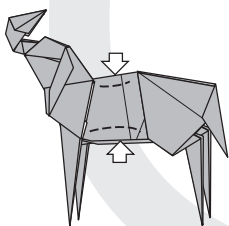

腹と背中を押し込み丸みをつける

137

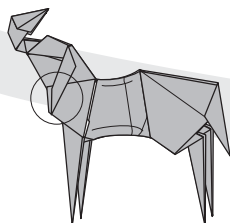

138

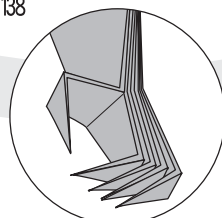

指の形を整える

139

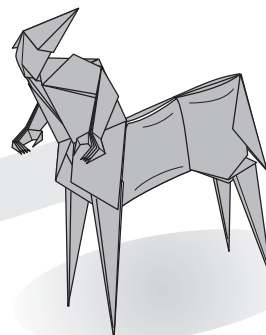

できあがり